

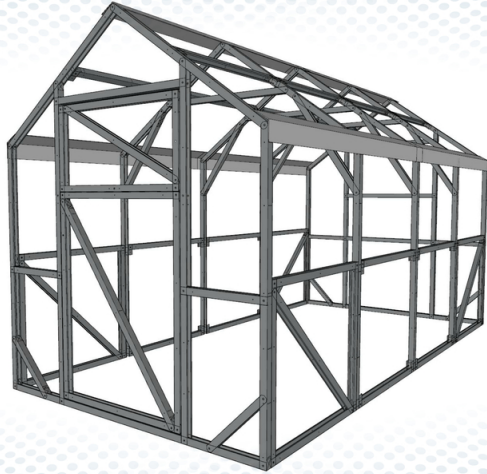







Instruction for assembling the 2x4m Greenhouse.

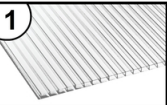
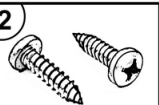

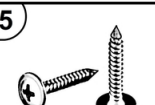
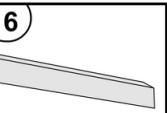
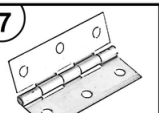
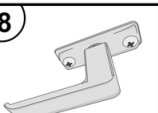
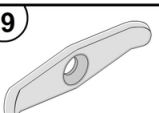
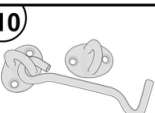
www.weisa.lv

Equipment

	Connection Element set 1 box.		Frame profile set 2 boxes.	
1 	2 	3 	4 	5 
Polycarbonate (thickness 4 mm, 1 sheet is 2,1x6m) 3 sheets.	Frame screws (DIN7981-5.5x19) 390 pcs.	For mounting hinges and Roof skates. Self-tapping screws (DIN7504N-4.8x19) 90 pcs.	Washers for polycarbonate (DIN9021 M8) 270 pcs.	Screws for polycarbonate (DIN7981-4.8x19) 270 pcs.
6 	7 	8 	9 	10 
Roof skates/Edges 8 pcs.	Hinges 8 pcs.	Door handles 2 pcs.	Latches 2 pcs.	Hooks 4 pcs.
11 	12 	Connection Elements 40 pcs.		
Corner 30x30 1 pcs.				

www.weisa.lv

Main View:

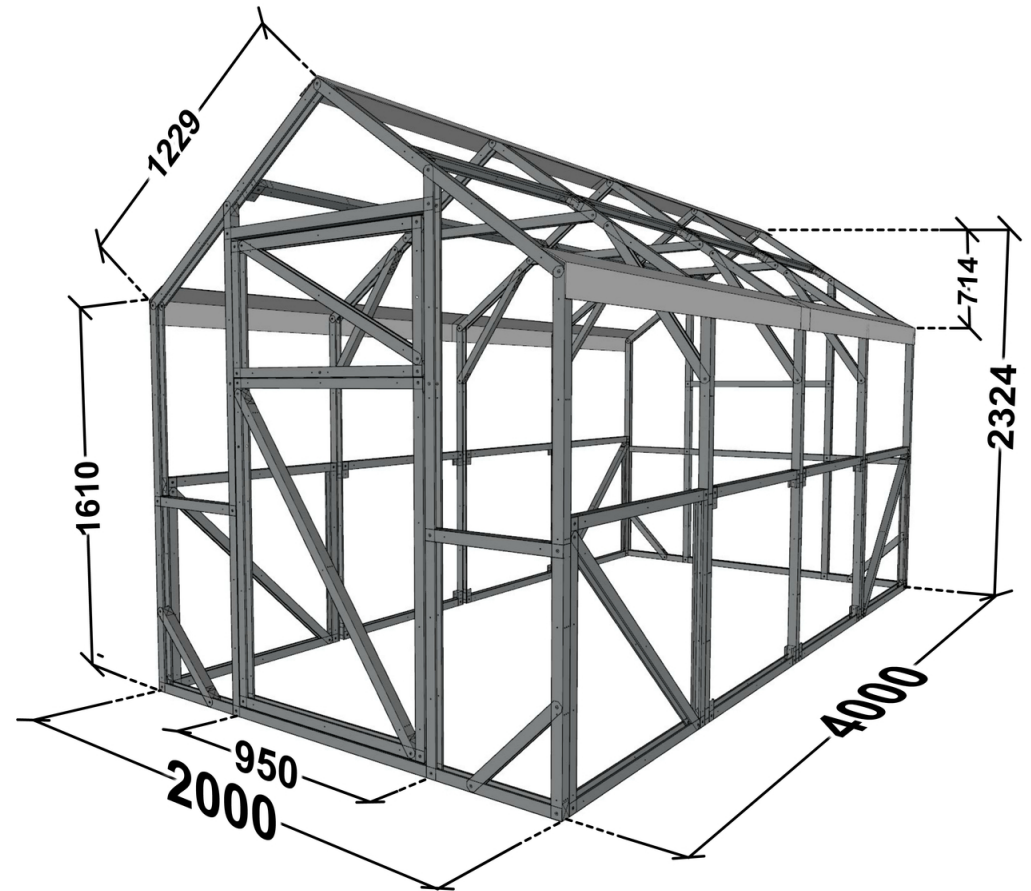

Door height : 1770 mm.
Door width : 940 mm.



Front View:

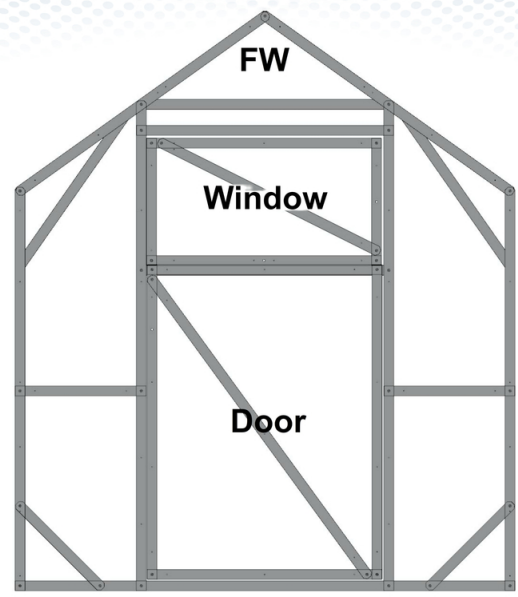

Side View:

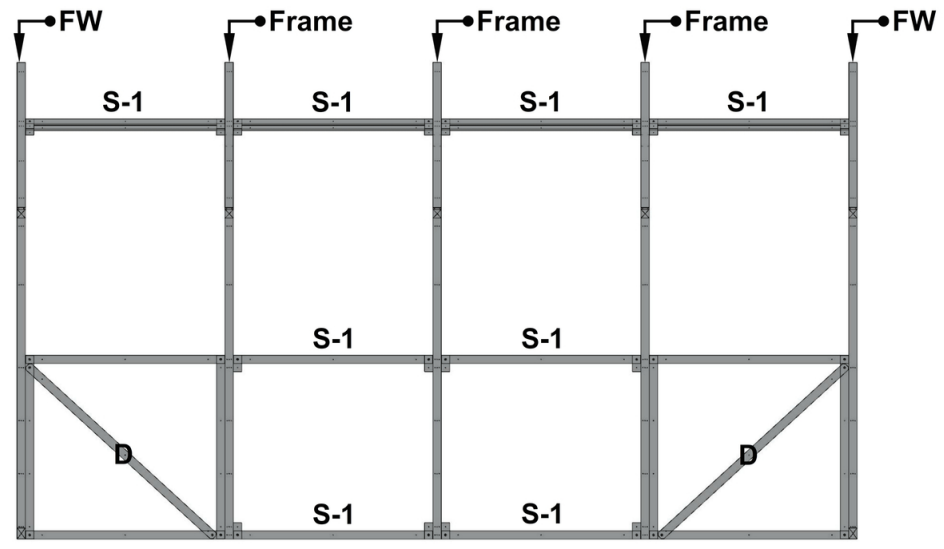

Top View:

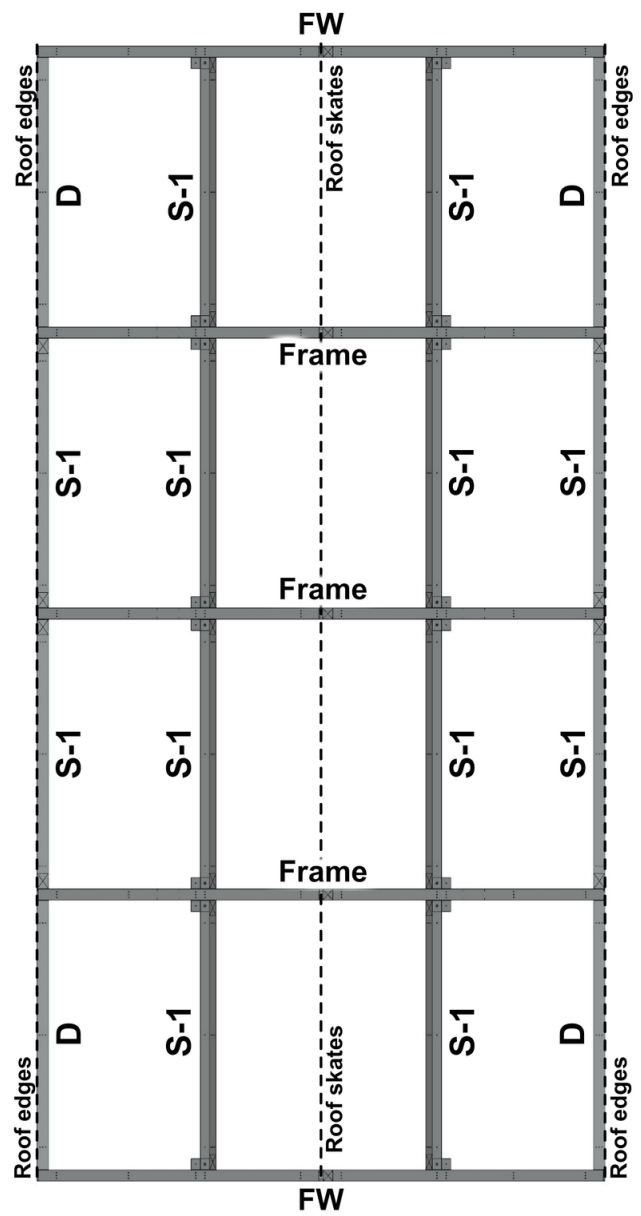

Instruction for assembling the 2x4m Greenhouse.



Unpack **One** box of **Connection Elements** and **One** box of **End Wall profiles**.

www.weisa.lv

2

Assemble **One** "FW1" panel and fasten it with screws (5.5x19):

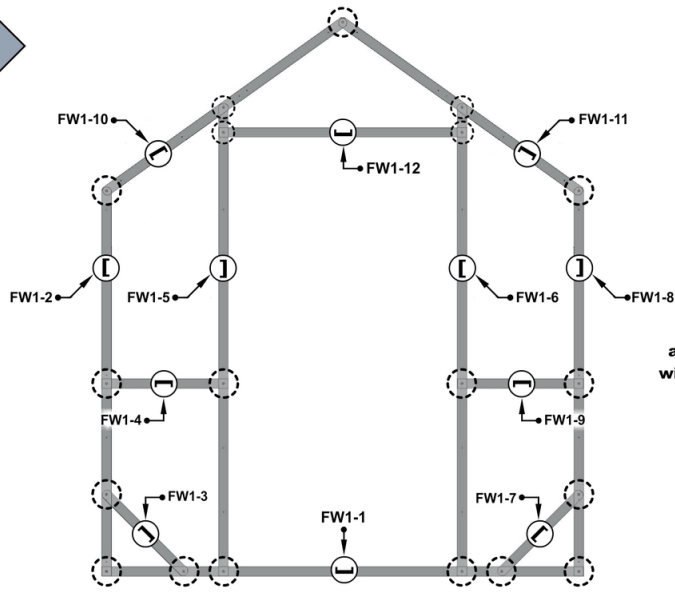

The connection points are indicated in the figure by dotted circles.

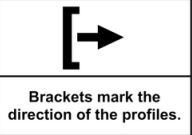

Carefully flip the panel and fasten the other side of the panel with screws according to the diagram.

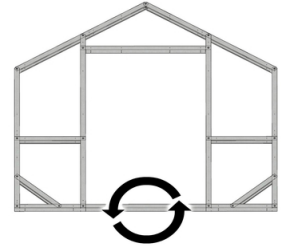

Fasten the **Connection Elements** with panels "FW1":

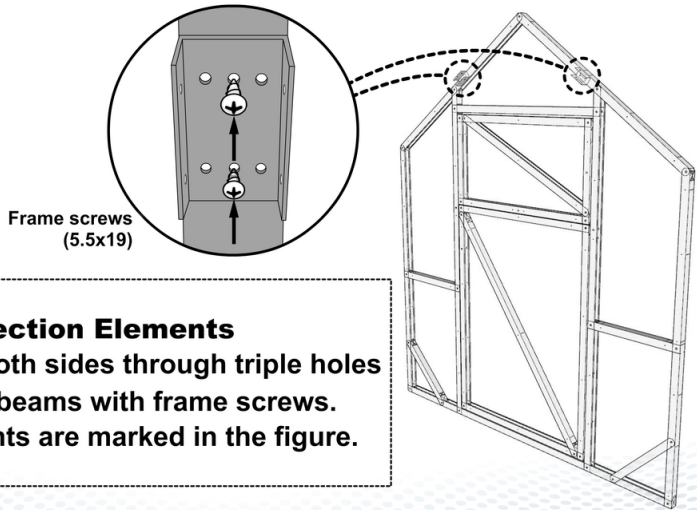

Connection Elements are fastened on both sides through triple holes in **FW1** panel beams with frame screws. Connection points are marked in the figure.

Instruction for assembling the 2x4m Greenhouse.



Unpack **One** box of "FW2" profiles.

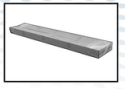

3

www.weisa.lv

4

Assemble **One** "FW2" panel and fasten it with screws (5.5x19):

The connection points are indicated in the figure by dotted circles.

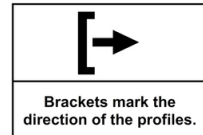

Carefully flip the panel and fasten the other side of the panel with screws according to the diagram.

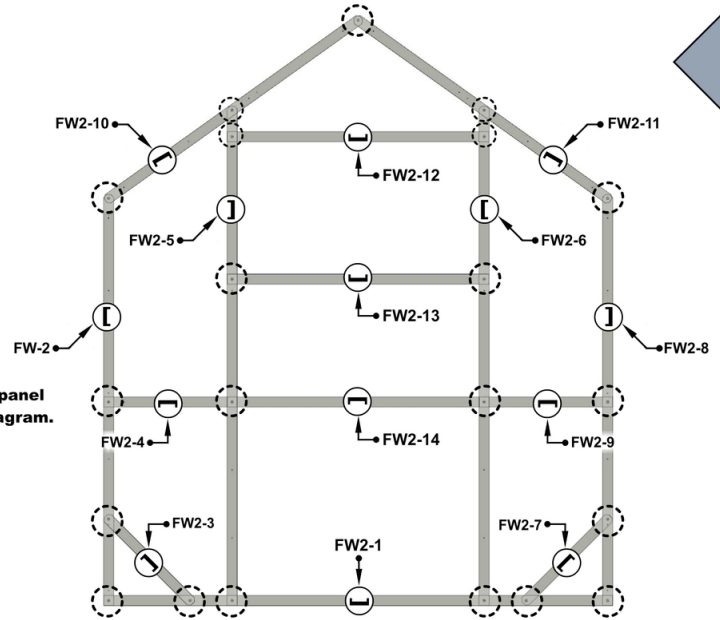
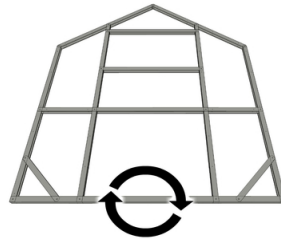

Fasten the **Connection Elements** with panels "FW2":

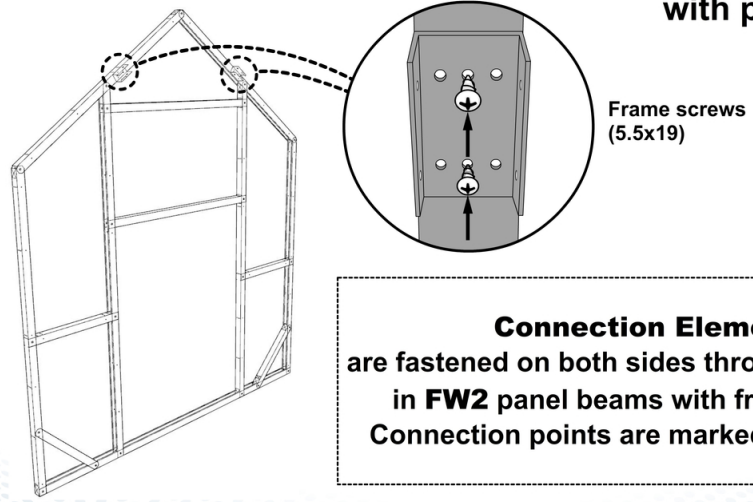

Connection Elements are fastened on both sides through triple holes in **FW2** panel beams with frame screws. Connection points are marked in the figure.

Instruction for assembling the 2x4m Greenhouse.



5



Unpack **One** box of "Frame" profiles.

www.weisa.lv

Assemble **One** "Frame" panel and fasten it with screws (5.5x19):

6

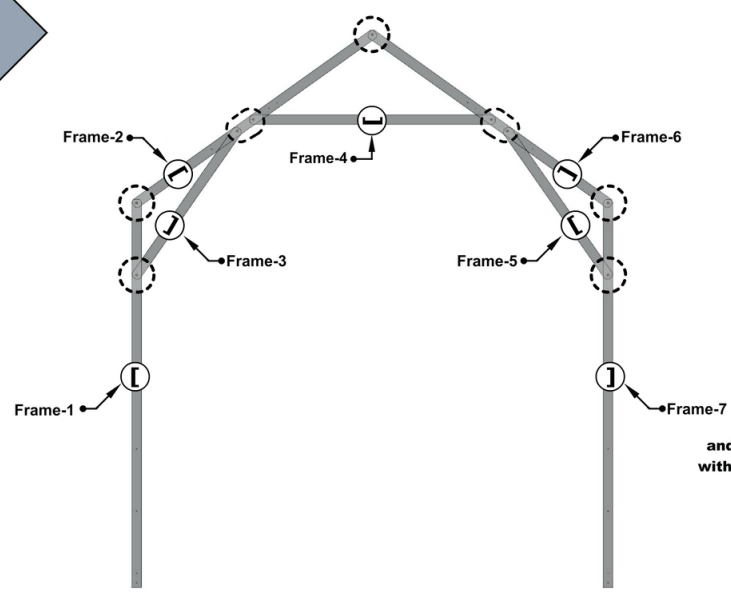

The connection points are indicated in the figure by dotted circles.

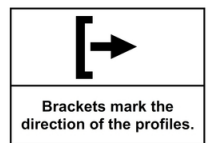

Carefully flip the panel and fasten the other side of the panel with screws according to the diagram.

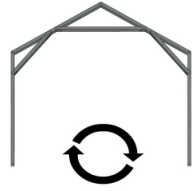

Fasten the **Connection Elements** with panels "Frame":

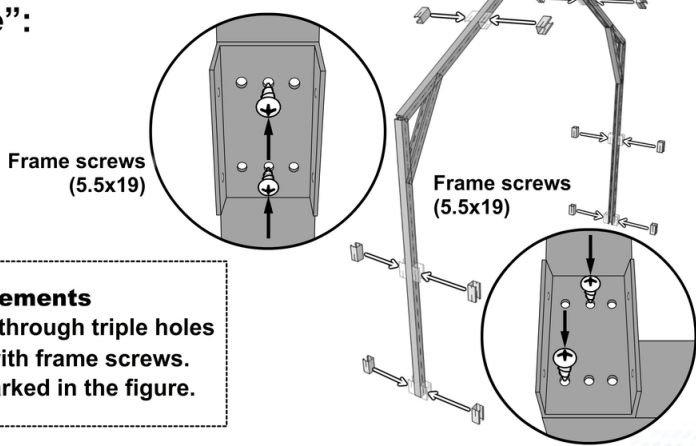

Connection Elements are fastened on both sides through triple holes in **Frame** panel beams with frame screws. Connection points are marked in the figure.

7

Repeat step 5 and 6 to assemble **2** additional "Frame" panels (3 pcs in total).

Instruction for assembling the 2x4m Greenhouse.



8

Unpack **One** box of "D" profiles.



www.weisa.lv

Assemble **Four** "D" panel and fasten it with screws (5.5x19):

9

The connection points are indicated in the figure by dotted circles.

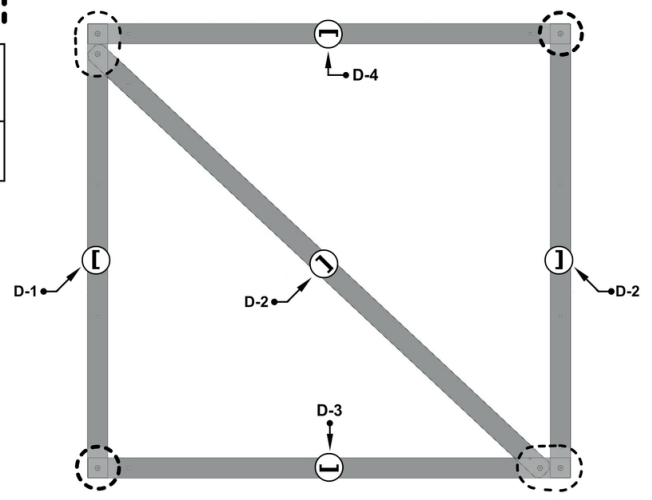
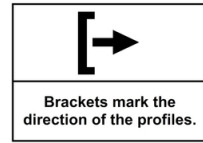

Carefully flip the panel and fasten the other side of the panel with screws according to the diagram.

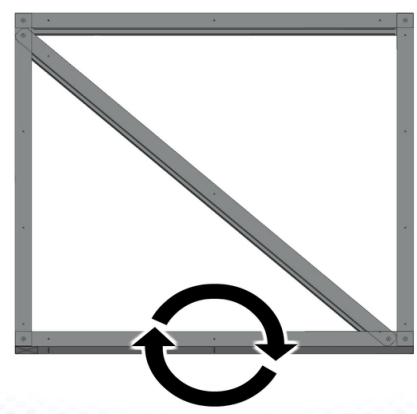

Instruction for assembling the 2x4m Greenhouse.



Assemble the frame by fastening together the panels and **Connection Elements**:

www.weisa.lv

10

- 1) Connect the "S-1" and "D" connection elements to the end wall "FW".
 - 2) Connect the "FRAME" panel.
- Fasten the panels with frame screws (5.5x19) according to the diagram:

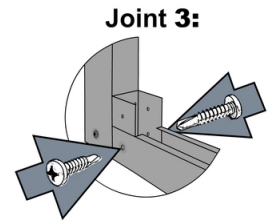
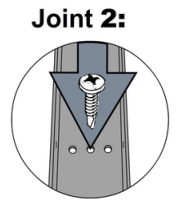
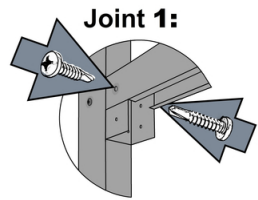
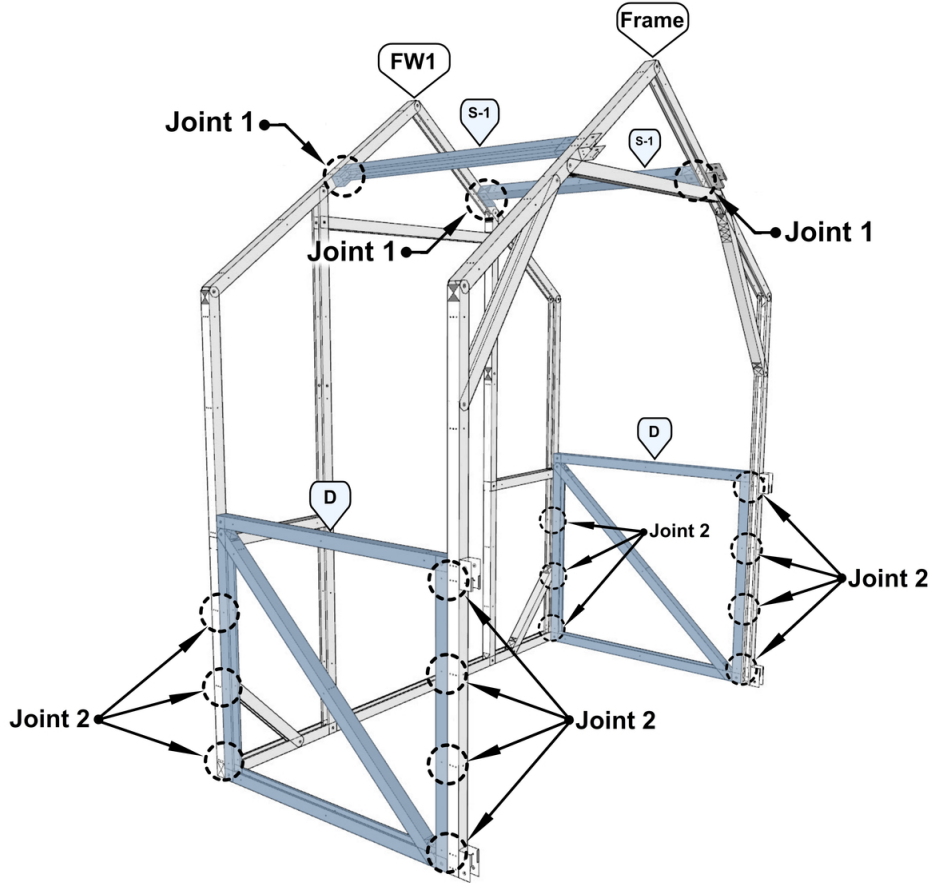

Similarly assemble the rest of the Greenhouse frame.

During montage assistance of a 2nd person is recommended.

Instruction for assembling the 2x4m Greenhouse.



www.weisa.lv

Install the Roof skates fastening them with Self-tapping screws:

11

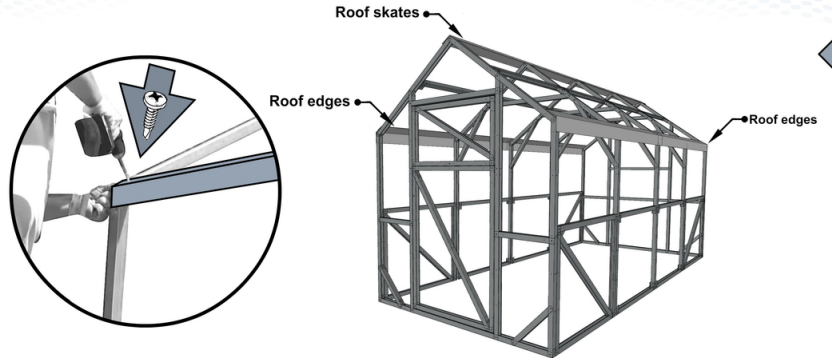

Assemble Door and Window panels:

Fasten the panel with frame screws (5.5x19) according to the diagram.



Brackets mark the direction of the profiles.

12

Hinges are installed on top of the polycarbonate covering.
A corner is used to block the door.

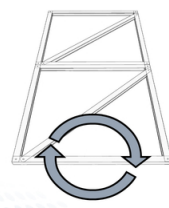
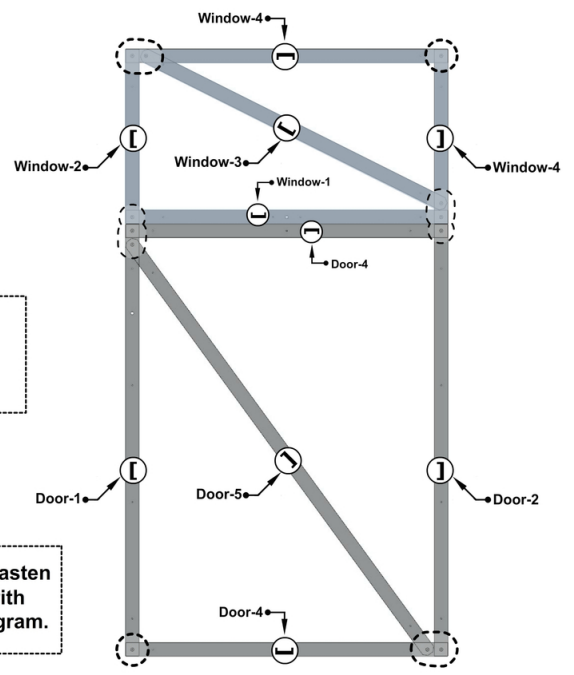

Carefully flip the panel and fasten the other side of the panel with screws according to the diagram.



www.weisa.lv

13

Polycarbonate Layout:

Polycarbonate is installed with the advertisement sticker facing outside.

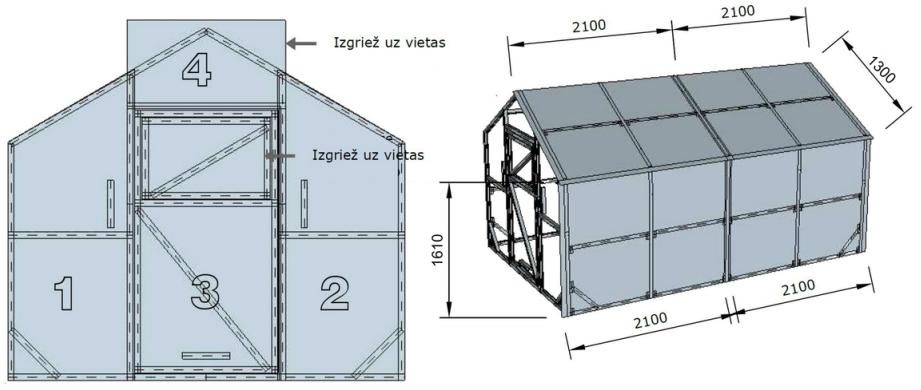
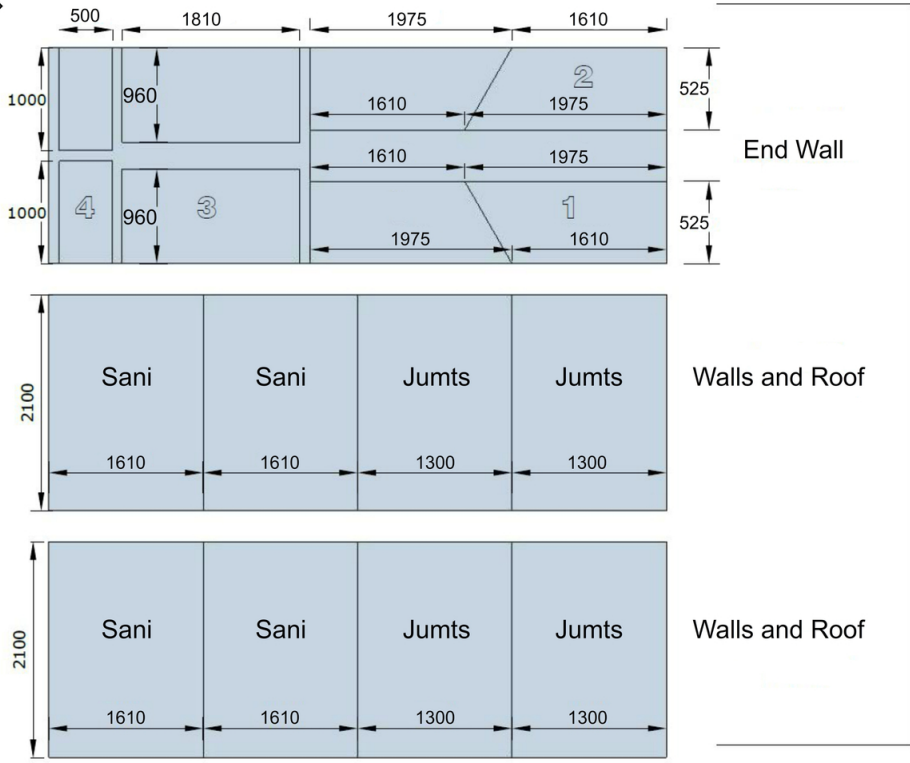

- Installation of polycarbonate on the walls and roof is provided with an overlap.
- For convenience, it is recommended to use a board during installation.



www.weisa.lv

14

Install the upper roof skates and roof edges on top of the polycarbonate coating using self-tapping screws:

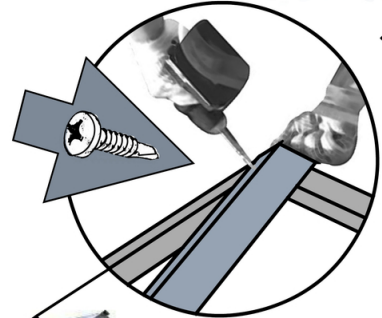



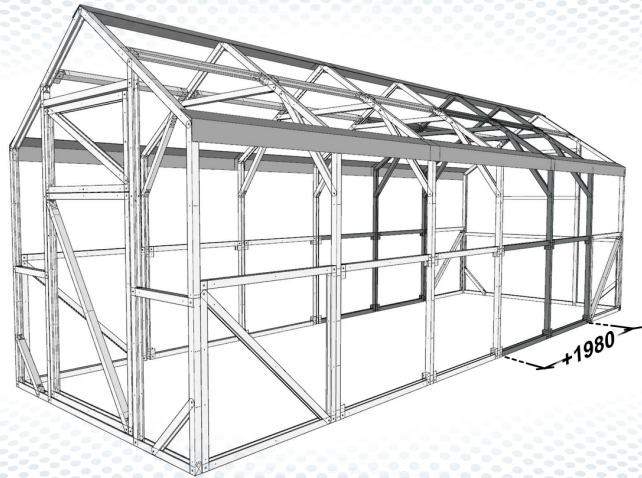

Instruction for assembling the Greenhouse 2x4m extension (1.98m).

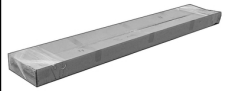
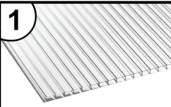
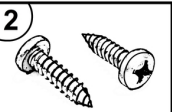
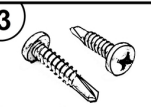

www.weisa.lv

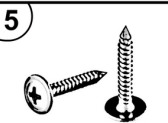
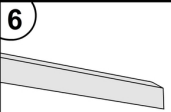
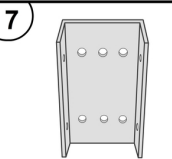
Equipment

	Connection Element set 1 box.		Frame profile set 1 box.
1  Polycarbonate (thickness 4 mm, 1 sheet is 2,1x6m) 1 sheet.	2  Frame screws (DIN7981-5.5x19) 140 pcs.	3  For mounting hinges and Roof skates. Self-tapping screws (DIN7504N-4.8x19) 20 pcs.	4  Washers for polycarbonate (DIN9021 M8) 60 pcs.
5  Screws for polycarbonate (DIN7981-4.8x19) 60 pcs.	6  Roof skates/edges 4 pcs.	7  Connection Elements 24 pcs.	

Main View:

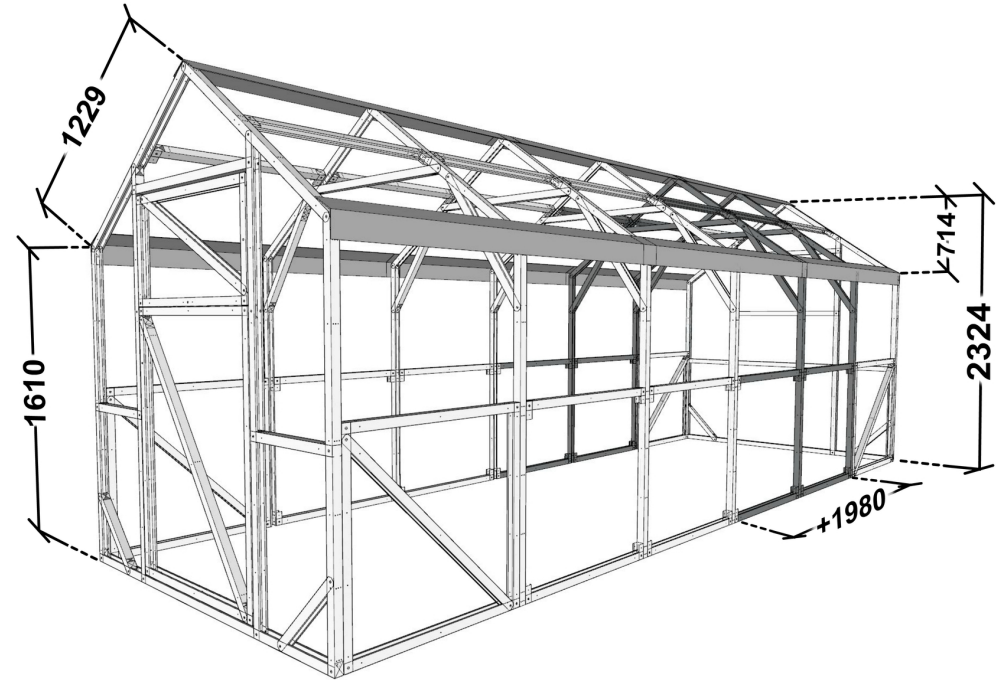



Front View:

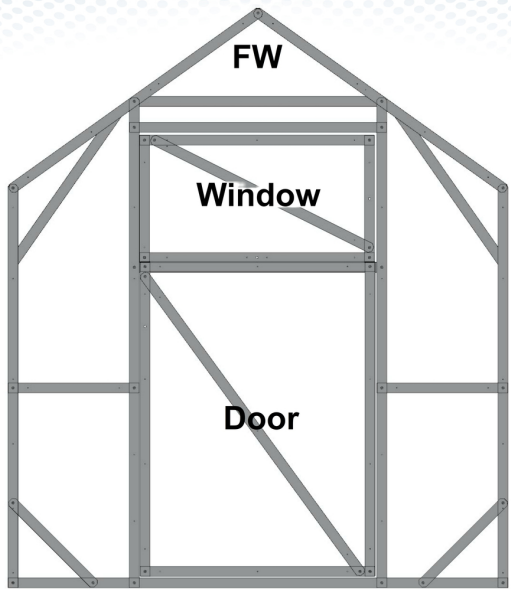

Side View:

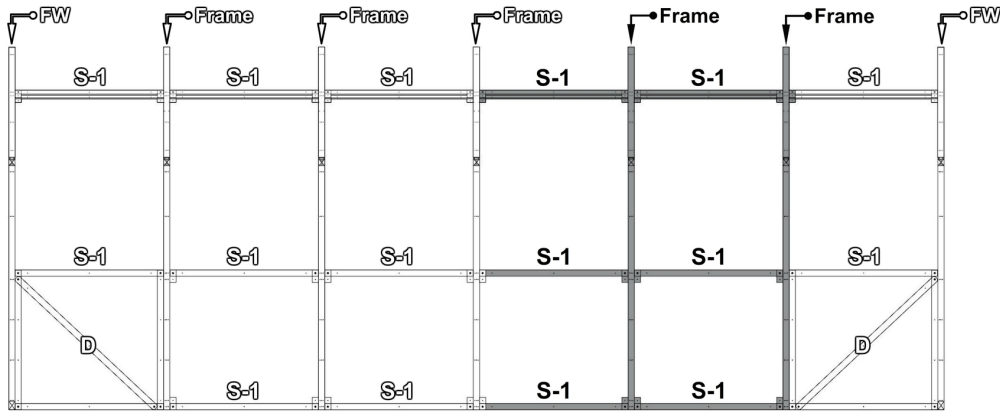

Top View:

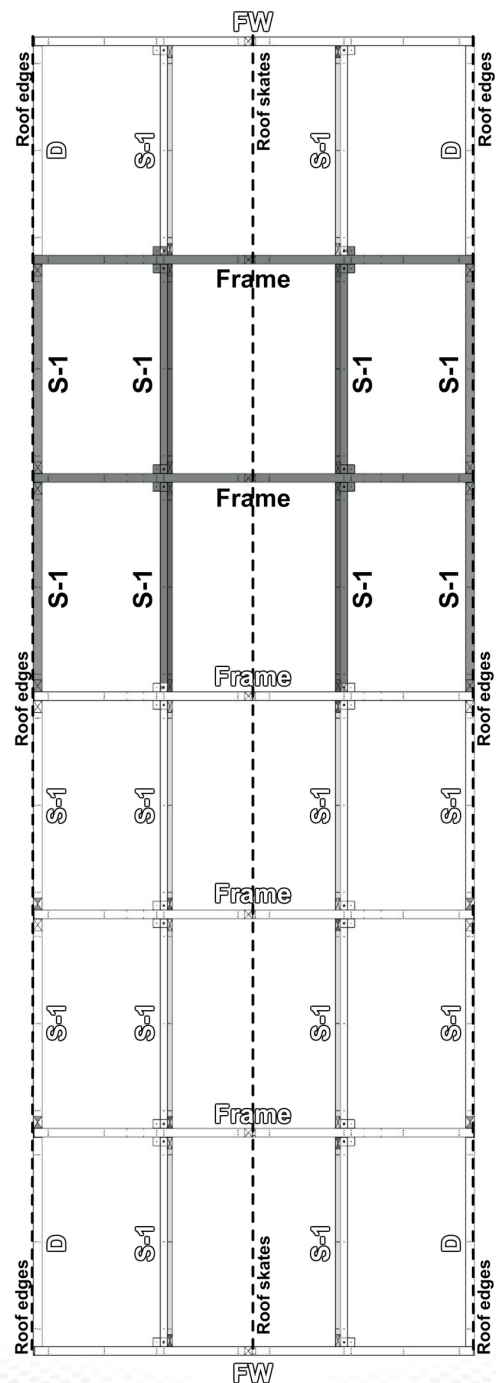



Unpack **One** box of **Connection Elements** and **One** box of **"Frame"** profiles.

2

Assemble **One** "Frame" panel and fasten it with screws (5.5x19):

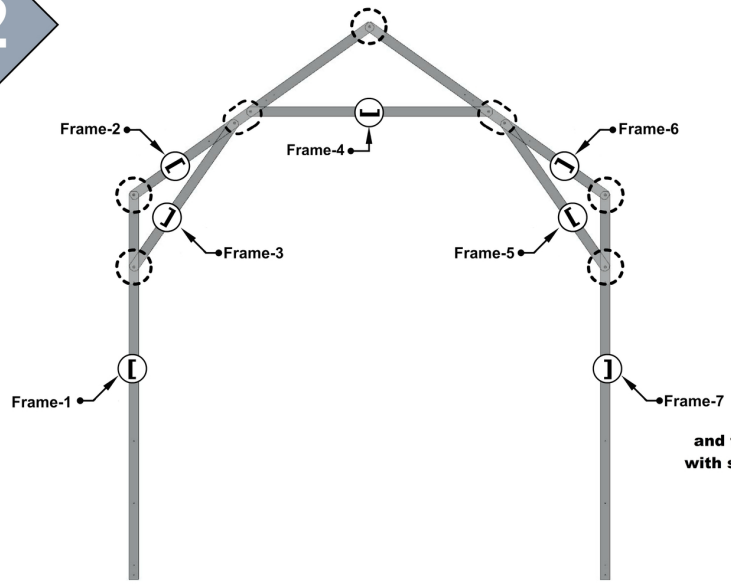

The connection points are indicated in the figure by dotted circles.

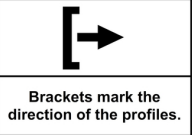

Carefully flip the panel and fasten the other side of the panel with screws according to the diagram.

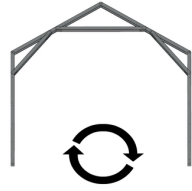

Fasten the **Connection Elements** with panels "Frame":

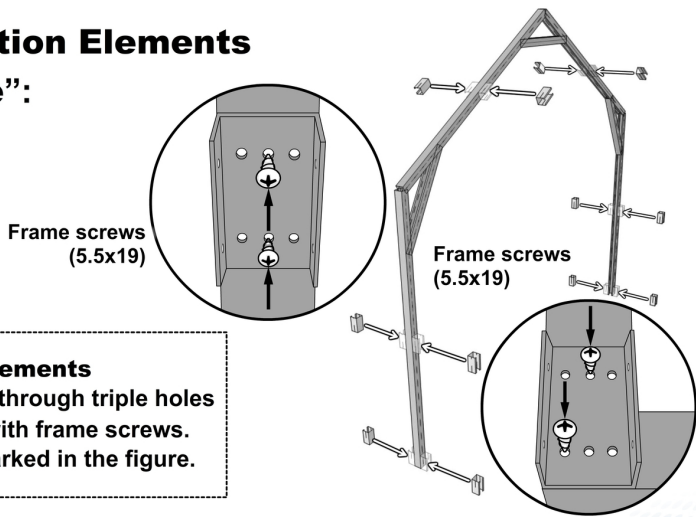

Connection Elements are fastened on both sides through triple holes in **Frame** panel beams with frame screws. Connection points are marked in the figure.

3 Repeat step 1 and 2 to assemble 1 additional "Frame" panels (2 pcs in total).



Assemble the frame by fastening together the panels and **Connection Elements**:

4

- 1) Connect the "S-1" and "D" connection elements to the end wall "FW".
 - 2) Connect the "FRAME" panel.
- Fasten the panels with frame screws (5.5x19) according to the diagram:

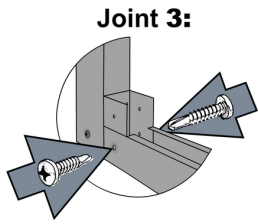
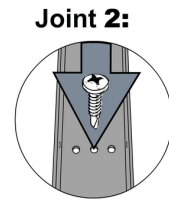
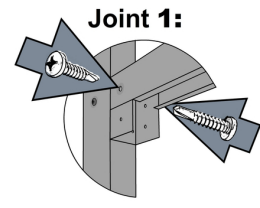
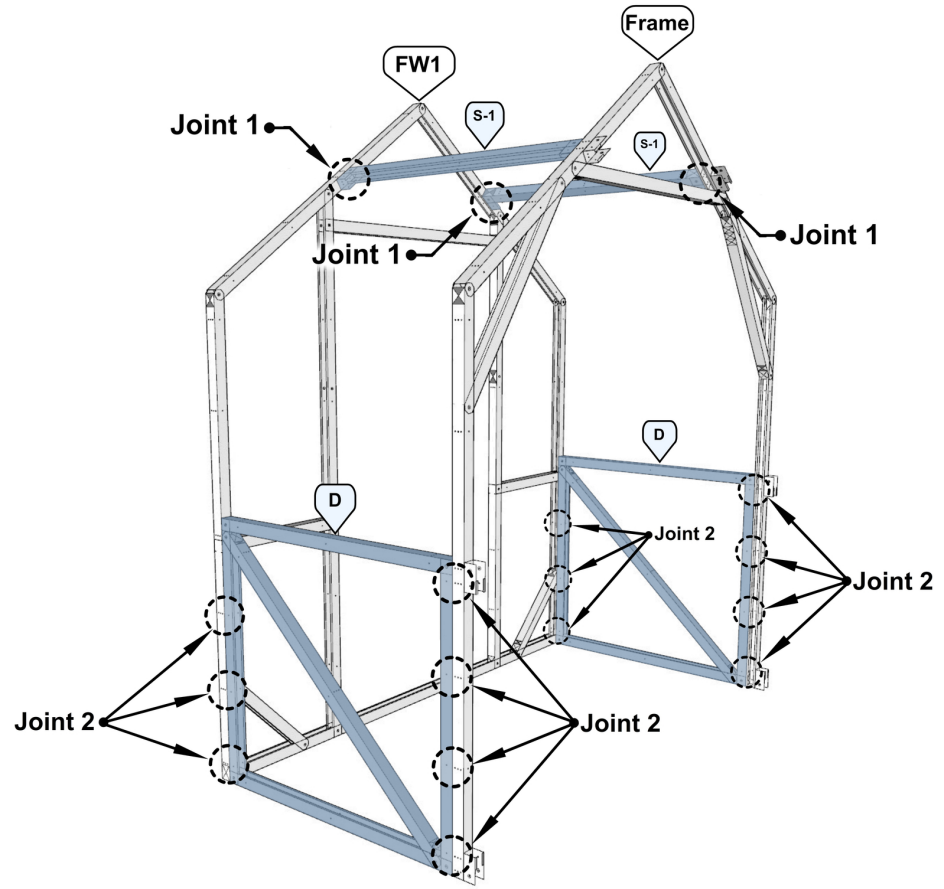

During montage assistance of a 2nd person is recommended.

Similarly assemble the rest of the Greenhouse frame.



www.weisa.lv

5

Install the Roof skates fastening them with Self-tapping screws:

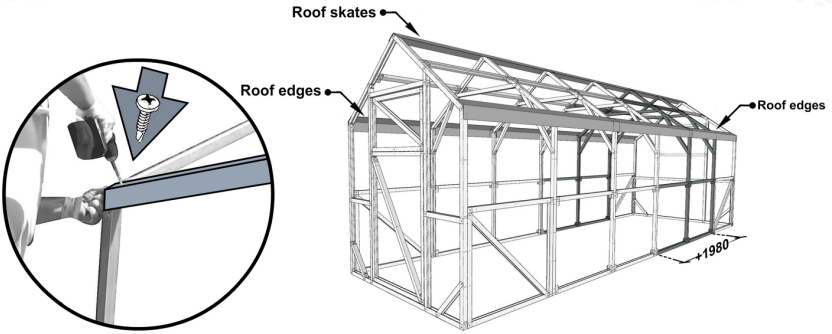

www.weisa.lv

Install the upper roof skates and roof edges on top of the polycarbonate coating using self-tapping screws:

7

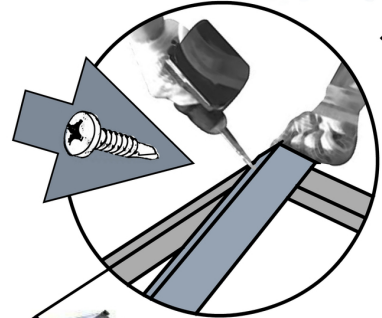

Polycarbonate Layout:

Polycarbonate is installed with the advertisement sticker facing outside.

6

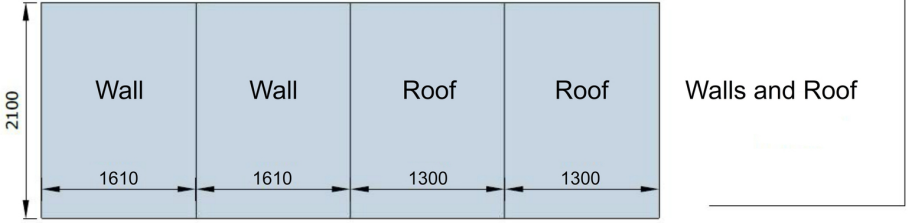

- Installation of polycarbonate on the walls and roof is provided with an overlap.
- For convenience, it is recommended to use a board during installation.

